





1 SERIES: 1.1

<http://tiny.cc/multione1-1EN>

 MAX LIFTING CAPACITY 250 kg	 ENGINE POWER 12 hp	 SPEED 8 km/h	 FLOW RATE 19 l/min	 LIFT HEIGHT 1,8 m
---	--	--	--	---

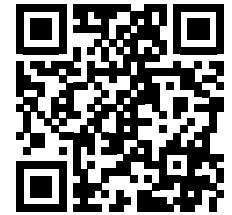

Model	1.1
Engine	Yanmar L100 - 1 cylinder - 435cc
Emission Standards	Stage V and Tier 4 Final
Power (Iso Gross) / Torque	12 HP / 21 Nm @ 3000 rpm
Fuel	Diesel
Transmission	Hydrostatic
Drive speed (max.)	8 km/h (5 mph)
Aux. hydraulics oil flow	19 l/min (5 GPM)
Max. lifting height	1,8 m (70.9 in)
Tipping load, max. ⁽¹⁾	320 kg (705 lbs)
Lifting capacity, max. ⁽²⁾	250 kg (551 lbs)
Breakout force / 50 cm (19.7 in)	250 kg (551 lbs)
Pushing force (c)	500 kgf (500 kp)
Average ground pressure (w/standard tires)	298 kg/m ² (61 lbs/sqft)
Turning radius: inside/outside	0/993 mm (0/39 in)
Standard tires (Tractor profile)	18x9.50-8
Weight	398 kg (880 lbs)
Product Code	C926006

⁽¹⁾ Tipping limit with rear weights and boom lifted just off the ground. Weight of attachment included.⁽²⁾ Maximum load that can be lifted just off the ground. Weight of attachment is included.

Note: Refer to the Operator's manual for the comprehensive load diagram.

MULTI ONE

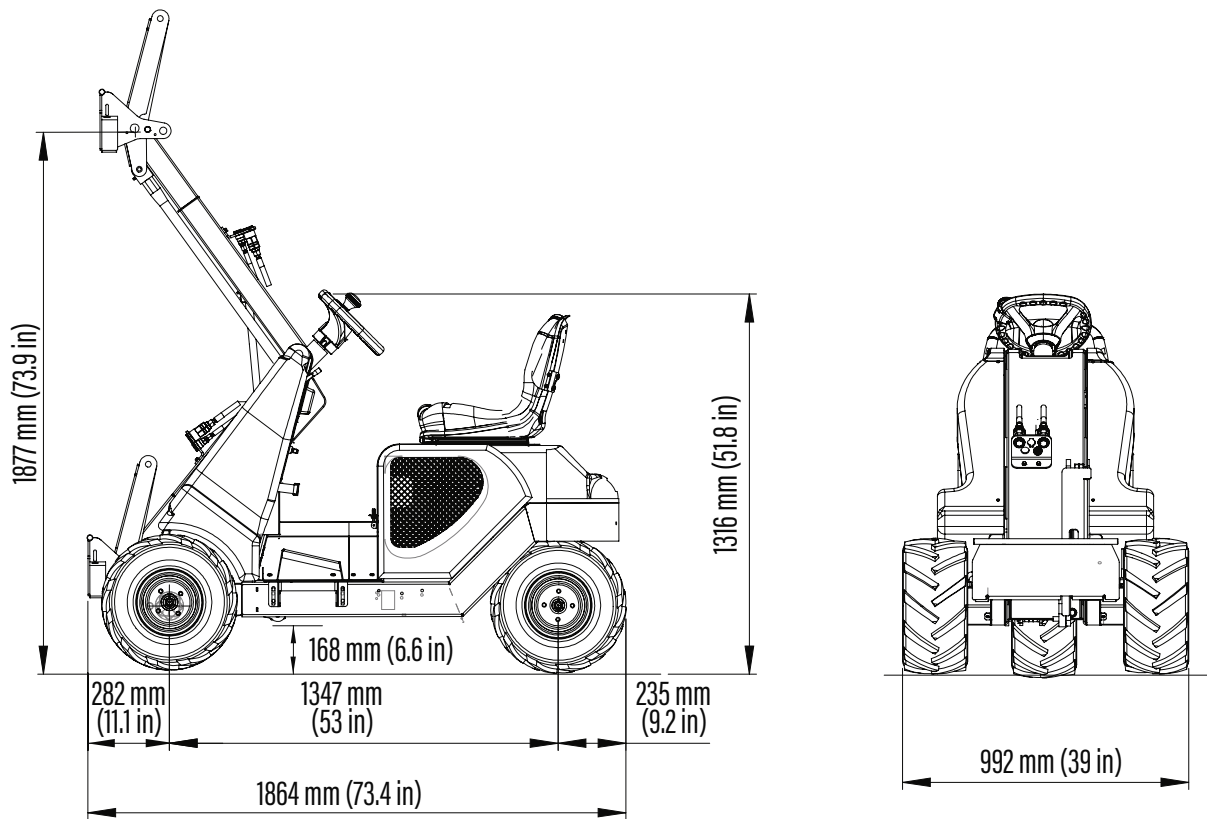

FEATURES

- YANMAR L100 engine, 1 cylinder, diesel engine, 435 cc, air cooled with electric start
- Stage V and Tier 4 Final compliant engine
- 3WD hydrostatic transmission with differential lock
- Variable displacement drive pump
- 3 line hydraulic outlets
- Boom with self-levelling
- 4-functions joystick
- Ergonomic seat with adjustable position
- Mechanical parking brake

Options	CODE
Biodegradable oil	C883059
Gps tracker	C883075
Turf tires 18x9.50-8, set of 3	C885023